



# Mid-States Concrete Industries

total precast CROSS SECTION & STRAND CONFIGURATIONS

6"X24" HOLLOWCORE

CROSS SECTION

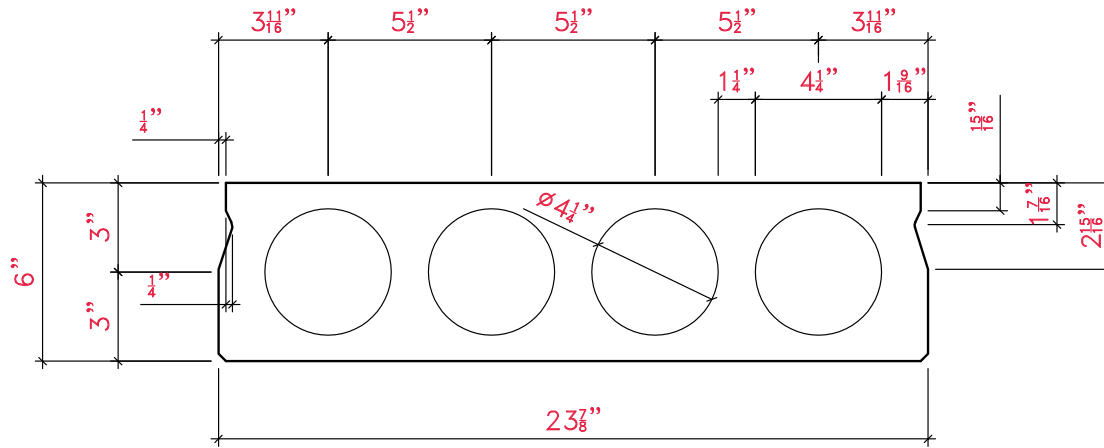

NOTES:

## STRAND CONFIGURATIONS

FOR INFORMATIONAL PURPOSES ONLY

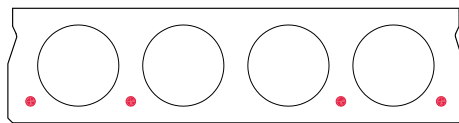

1.0-2627  
1.0-46

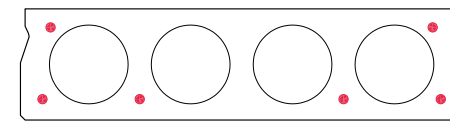

1.0-2627TC26  
1.0-2627TP26  
1.0-46TP26



# Mid-States Concrete Industries

total precast CROSS SECTION & STRAND CONFIGURATIONS

6"X18" HOLLOWCORE

CROSS SECTION

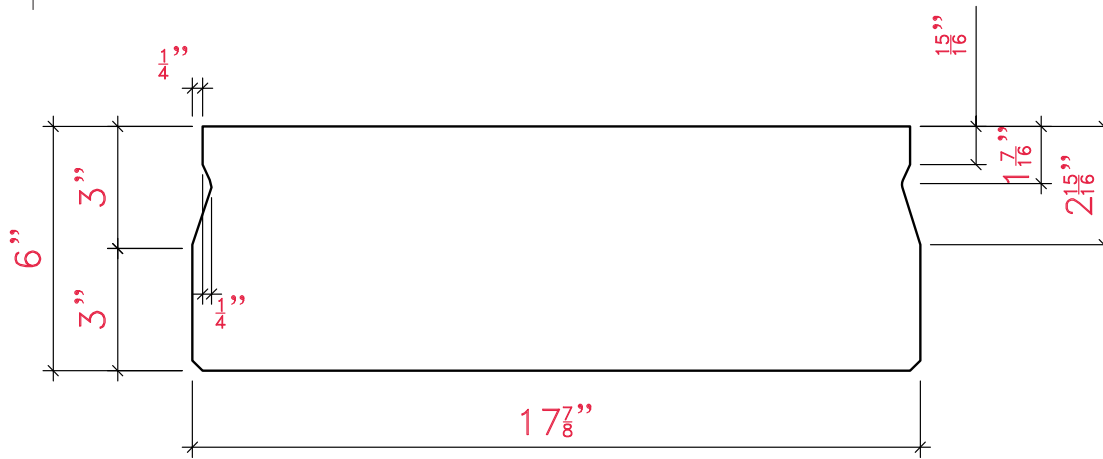

NOTES:

## STRAND CONFIGURATIONS

FOR INFORMATIONAL PURPOSES ONLY

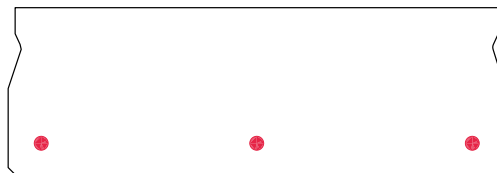

1.0-F37

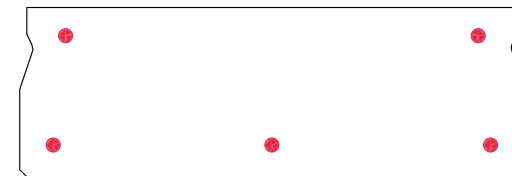

1.0-F37TC26



# Mid-States Concrete Industries

total precast CROSS SECTION & STRAND CONFIGURATIONS

6"X16" HOLLOWCORE

CROSS SECTION

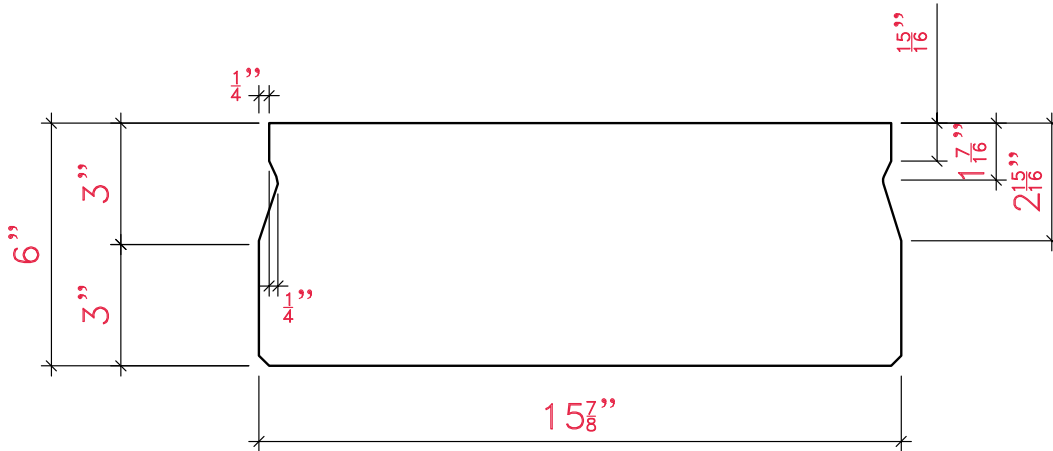

NOTES:

## STRAND CONFIGURATIONS

FOR INFORMATIONAL PURPOSES ONLY

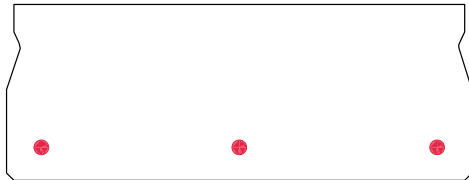

1.0-F37

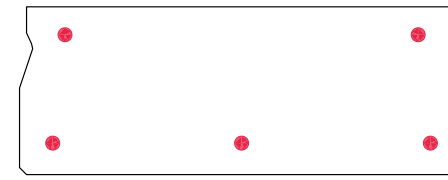

1.0-F37TC26