



Mid-States Concrete Industries

total precast CROSS SECTION & STRAND CONFIGURATIONS

8"X18" HOLLOWCORE

CROSS SECTION

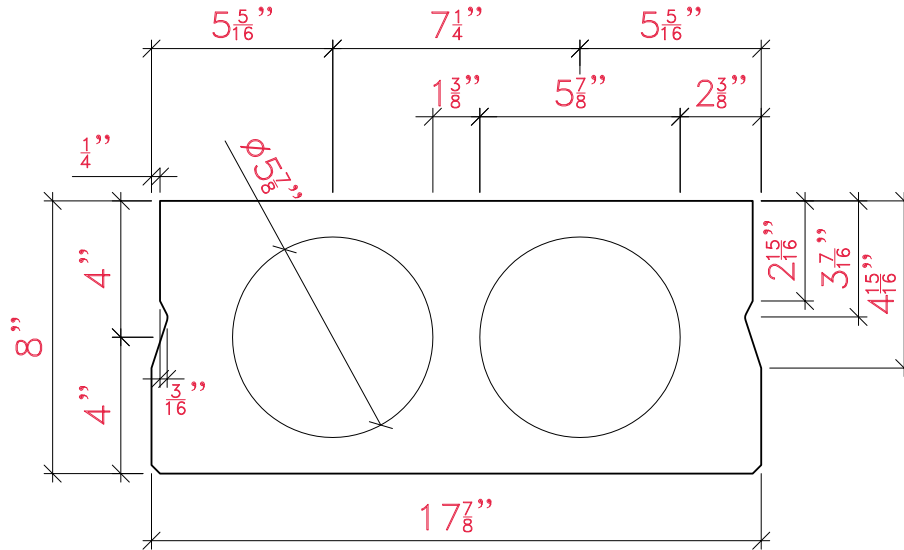

NOTES:

STRAND CONFIGURATIONS

FOR INFORMATIONAL PURPOSES ONLY

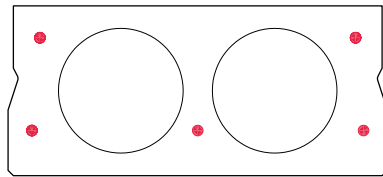

- 2.0-F37TC26
- 2.0-F37TP26
- 2.0-F38TC26
- 2.0-F38TP26
- 2.0-F38+STC26
- 2.0-F38+STP26

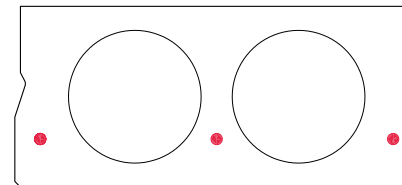

- 2.0-F37
- 2.0-F38
- 2.0-F38+S