



Mid-States Concrete Industries

total precast CROSS SECTION & STRAND CONFIGURATIONS

12"X24" HOLLOWCORE

CROSS SECTION

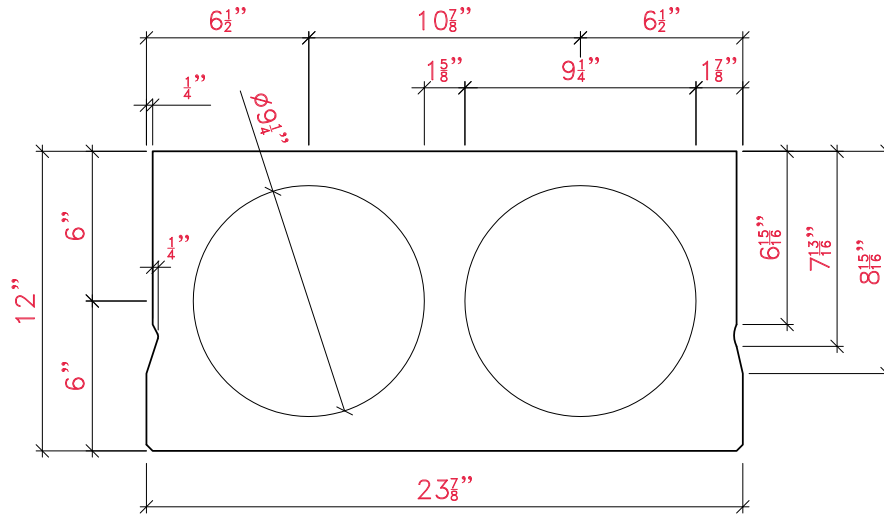

NOTES:

STRAND CONFIGURATIONS

FOR INFORMATIONAL PURPOSES ONLY

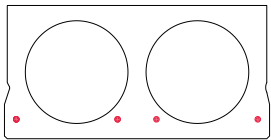

1.5-2627
1.5-47

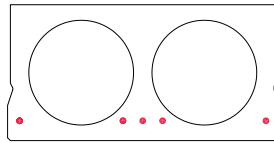

1.5-57

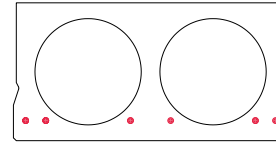

1.5-67

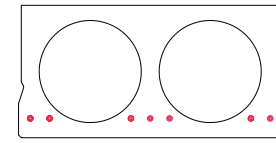

1.5-77
1.5-78
1.5-78+S

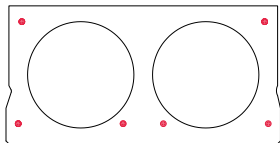

1.5-2627TC26
1.5-2627TP26
1.5-47TC26
1.5-47TP26

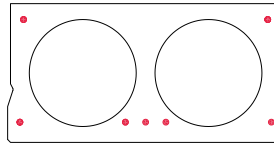

1.5-57TC26
1.5-57TP26

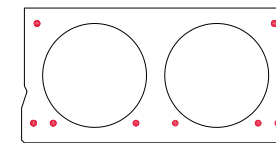

1.5-67TC26
1.5-67TP26

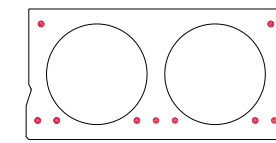

1.5-77TC26
1.5-77TP26
1.5-78TC26
1.5-78TP26
1.5-78+STC26
1.5-78+STP26

