



Mid-States Concrete Industries

total precast CROSS SECTION & STRAND CONFIGURATIONS

12"X18" HOLLOWCORE

CROSS SECTION

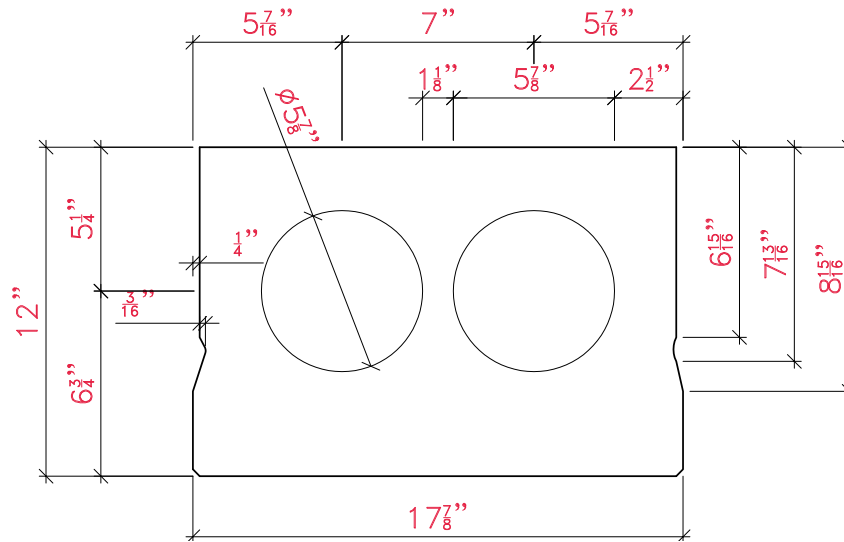

NOTES:

STRAND CONFIGURATIONS

FOR INFORMATIONAL PURPOSES ONLY

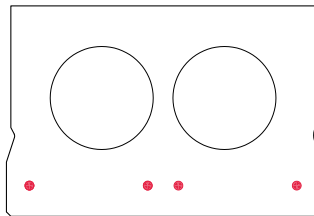

1.5-F47
1.5-F48
1.5-F48+S

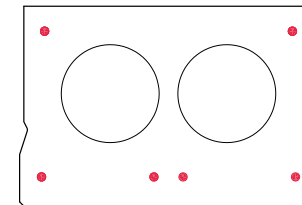

1.5-F47TC26
1.5-F47TP26
1.5-F48TC26
1.5-F48TP26
1.5-F48+STC26
1.5-F48+STP26